



Masdar Elemar
International

COMPANY PROFILE

2026





Greeting from the CEO

Dear Partners, Clients, and Stakeholders,

On behalf of Masdar El Emar International, I am pleased to extend our warmest greetings and introduce our company's vision, values, and capabilities.

Founded with a commitment to excellence, Masdar El Emar International has established itself as a trusted name in general trading, engineering, procurement, and contracting services. Our journey is built on professionalism, integrity, and a relentless pursuit of quality in everything we do.

As CEO, I take pride in leading a dedicated team of experts who work tirelessly to deliver innovative solutions, meet complex project requirements, and build long-term partnerships across Iraq and the wider region.

We look forward to new opportunities, mutual collaboration, and continued growth as we strive to contribute to the economic and industrial development of our markets.

Thank you for your trust and interest in Masdar El Emar International.

**With respect,
Mr. Ausama Sh. Hmod
Chief Executive Officer
Masdar El Emar International**



Everything About Us

Masder Company is one of the well-known companies operating in Iraq in several aspects and sections.

Masder Company is one of the well-known companies operating in Iraq in several aspects and sections: inter alia in terms of petroleum, construction, General Trading and Engineering service. Masder Elemar Co. has a technical, administrative and engineering with distinctive and multiple experiences staff.

The company has been submitted by the General Manager Mr. Ausama Shumran Hmod " with a budget of 1,000,000,000 Iraqi dinars (approximately 850 million US dollars), also its registered in several ministries and department Iraq :

Registered with Ministries

- The Iraqi Ministry of Trade / Department Registrar of Companies.
- The Iraqi Ministry of Planning
- The Iraqi Ministry of Oil / Drilling and Rehabilitation of oil fields Department.
- The Central Bank of Iraq.
- The General Commission for Taxes Federation of Iraq Chambers of Commerce.
- The chamber of Trading in Wassit city. Headquarters lawyers.
- Department of pension and social security.
- Documentation and Information Department.

CV

Where Masder Al-Eemar Co. for General Trading & Construction & human development and technical personnel in various fields service for the benefit of our dear country.



*You Name it
We'll have it
for You*

Where Masder Al-Eemar Co. for General Trading & Construction & human development and technical personnel in various fields service for the benefit of our dear country.

The Company address : IRAQ, BAGHDAD, Jaderyah, Nearby Baghdad University.

Masder Al Eemar company had Contracted and worked with several international oil companies and sober ones like :

**PETRO CHINA, BP, CNPC,
GAZPROM, ZPEC, DNO,
MULTRONIC AUTOPOWER,
ALWAHA
PETROLEUM COMPANY,
SHELL & MDOC**

High Quality Petroleum Products

Masdar Elemar International provides high quality products to petroleum industry as per required specifications.



*You Name it
We'll have it*

We obtained Certifications to fulfil industry requirements to meet industry standard



We obtained Certifications to fulfil industry requirements to meet industry standard





Our Services

- Workover and well services (W/O unit and related services, rentals)
- Training service with certificate
- Rig inspection with (API)
- Fishing, liner hanger.
- Completions (SPM, NF, ALS, perforations, testing RTTS, PT packer) services.
- Coiled tubing services (Nitrogen, Flow back equipment, Pumping services).
- Slickline services (running GLVs, shifting SSD, punching, MPLT (survey), etc)
- Casing & Tubing Tubular Running Services
- Handling tools on rental.
- API Casing & Tubing Lubricants.
- Casing Access., Centralizers & Stops.
- Solid Control & Waste Management, Filtration unit

Services

The goal of Masder Al-Eemar Co. is to provide value to their clients, by offering high-quality, tailored services that meet their clients' needs, and continuously improve the services provided.



*Authorized
Services
Provider*

Masder Al-Eemar Co. as a service provider is to offer a service or set of services to our clients that meets their needs and exceeds their expectations. This can include a wide range of services.

Building long-term relationships with clients: Masdar Elemar often strive to build trust and loyalty with our clients, so that we may continue to provide services over time.

Continuously improving services: Masdar Elemar want to continuously improve its services, so that we can stay competitive and meet the changing needs of our clients.



Services

Masdar Elemar International offers specialized Radial Drilling Services designed to significantly enhance hydrocarbon recovery. By employing advanced radial drilling techniques, we create multiple horizontal boreholes branching out from existing wells, maximizing reservoir contact and boosting production. This method is particularly effective in mature fields or complex reservoirs, allowing for increased drainage and optimized well performance. Our expertise in radial drilling helps clients unlock untapped potential, improve production rates, and extend the economic life of their assets.

Radial Drilling

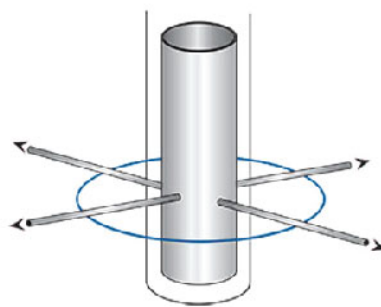
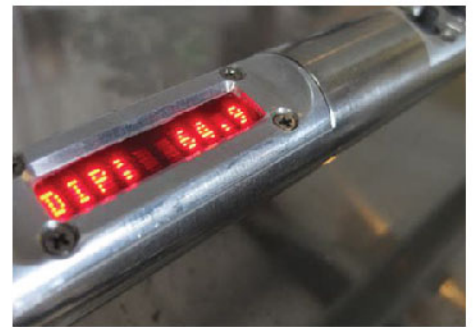



Services

Masdar Elemar International provides comprehensive workover drilling rig services, focusing on maximizing well productivity and extending the lifespan of existing assets. Our services encompass a range of interventions, including well repairs, recompletions, and stimulations, all executed with a strong emphasis on safety and efficiency. We deploy experienced crews and utilize modern workover rigs to address diverse well challenges, from routine maintenance to complex remedial operations. By leveraging our expertise, we help clients optimize production, reduce downtime, and achieve cost-effective well management.

Workover Drilling Rig

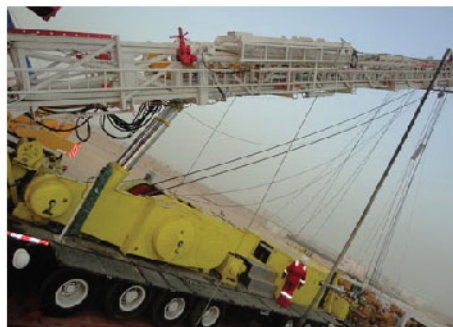



Pipeline Construction:

Pipeline trenching, laying, welding, and backfilling.
Hydrostatic testing and commissioning.
Pipeline integrity management.

Facility Construction:

Construction of oil and gas processing facilities.
Construction of storage tank farms.
Construction of industrial buildings.

Maintenance and Repair:

Routine maintenance and repair of industrial facilities and equipment.
Emergency repairs and troubleshooting.
Preventive maintenance programs.

Construction

Masdar Elemar International's Construction Services are built on a foundation of quality, safety, and efficiency, providing comprehensive solutions for a wide range of projects, particularly within the demanding environment of the petroleum industry. Here's a more detailed look:

Site Preparation and Earthworks:

Land clearing, grading, and excavation.
Compaction and soil stabilization.
Construction of access roads and platforms.
Drainage and erosion control.

Concrete and Steel Construction:

Foundation construction for industrial facilities and equipment.
Reinforced concrete structures, including buildings, tanks, and pipelines.
Structural steel fabrication and erection.
Welding and fabrication services, adhering to industry standards.

Equipment Installation and Erection:

Installation of heavy equipment, including pumps, compressors, and generators.
Piping installation and testing.
Mechanical equipment erection and alignment.
Commissioning support.

Welding and Fabrication:

Certified welding services for various materials, including carbon steel, stainless steel, and alloy steel.
Fabrication of structural steel, piping systems, and pressure vessels.
Adherence to international welding codes and standards.
Nondestructive testing.

Quality Control and Assurance:

Implementation of rigorous quality control procedures at all stages of construction.
Inspection and testing of materials and workmanship.
Documentation and record keeping.
Adherence to client specifications and industry standards.



Construction

Masdar Elomar International is staffed and supervised by qualified and comprehensive engineers with extensive experience in the field of petroleum and civil engineering who are familiar with the changing patterns and strategies in the business.

Living Camps



Office Construction





Construction

Petroleum Industry Expertise:

Understanding the specific requirements of oil and gas construction.
Experience working in challenging environments.
Knowledge of relevant industry regulations and standards.

Quality:

Commitment to delivering high-quality workmanship.
Use of high-quality materials and equipment.
Rigorous quality control and assurance processes.

Professional Hard Workers





Engineering

This division of Masdar Elemar International provides comprehensive, end-to-end solutions for a wide range of construction and engineering projects, with a particular emphasis on the demands of the petroleum industry. We leverage our expertise and resources to deliver projects that are safe, efficient, and meet the highest quality standards.

Casing Running Tool (CRT)

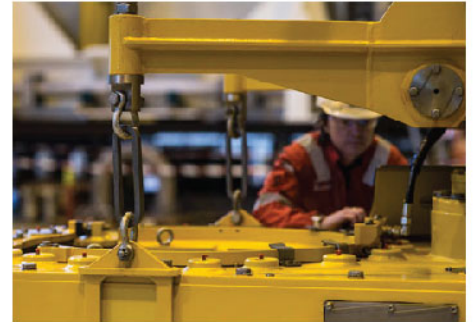

Virtual Thread Rep (VTR)





Engineering

Masdar Elemar International is staffed and supervised by qualified and comprehensive engineers with extensive experience in the field of petroleum and civil engineering who are familiar with the changing patterns and strategies in the business.

Electric Generation



A grayscale photograph of an industrial refinery facility, featuring tall distillation columns, complex piping, and storage tanks. A large green diagonal shape is overlaid on the right side of the image, containing the title text.

Refinery Procurement & Services

- Motorized valves
- Flow metering and monitoring solutions
- Hydrogen PSA
- Nitrogen PSA
- Industrial Automation
- Cathode Protection Systems
- Storage Tanks and Pressure Vessels
Piping (Under and Over Ground)



Refinery

Masdar Elemar International supplies essential Flow Metering and Monitoring systems designed for the demanding requirements of Iraq's petroleum industry and refineries. Our solutions provide highly accurate measurement and real-time tracking of critical fluid flows – including crude oil, natural gas and refined products. This precise data is vital for optimizing process control, ensuring fiscal accuracy for custody transfer, enhancing operational efficiency, and upholding safety protocols within complex energy operations.

Flow Metering & Monitoring





Refinery

Masdar Elemar International provides robust Motorized Valves engineered for reliable performance in Iraq's demanding petroleum industry and refinery applications. These actuated valves utilize electric motors for remote and automated operation, enabling precise control over the flow of oil, gas, water, and various process fluids. Essential for modern process automation, our motorized valves integrate seamlessly with plant control systems (like DCS or SCADA) and are critical components in safety systems, including emergency shutdown (ESD) functions, ensuring operational efficiency and enhanced plant safety.

Motorized Valves





Refinery

High-Purity Hydrogen Recovery from Platforming Net Gas

This project showcases a high-performance hydrogen purification system designed to recover hydrogen from Platforming Net Gas using PSA (Pressure Swing Adsorption) technology.

This system delivers reliable, high-purity hydrogen for downstream processes while maximizing efficiency and throughput from existing refinery streams.

Hydrogen PSA





Refinery

PSA Nitrogen Generation System

An efficient, fully integrated PSA system designed for high-purity, on-site nitrogen production.

A robust solution ideal for industrial applications requiring continuous, clean nitrogen supply with minimal maintenance.

Nitrogen PSA





Refinery

Masdar Elemar International offers Industrial automation for refineries (using robotics and control systems). It focuses on enhancing the efficiency, safety, and precision of refinery operations through the integration of advanced robotics and sophisticated control systems. Robots can perform tasks ranging from inspections and maintenance in hazardous areas to precise handling of materials and equipment. Integrated control systems provide real-time monitoring, data analysis, and automated adjustments to optimize refining processes, reduce downtime, and improve overall productivity. This technology aims to minimize human intervention in dangerous environments and ensure consistent, high-quality output.

Industrial Automation





Refinery

Masdar Elemar International offers specialized Cathodic Protection (CP) services designed to safeguard critical metal assets within Iraq's petroleum industry and refineries. This vital service employs electrochemical principles to prevent corrosion on storage tanks (both above-ground and buried) and extensive piping networks, protecting them from degradation caused by soil and environmental factors. Our expert solutions, encompassing system design, installation, monitoring, and maintenance of both Galvanic and Impressed Current CP systems, ensure the long-term integrity of your infrastructure, prevent costly leaks, enhance safety, and significantly extend the operational lifespan of essential equipment.

Cathode Protection

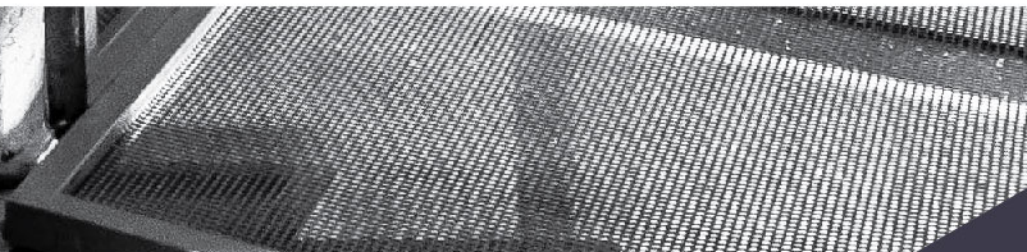



Refinery

Masdar Elemar International provides comprehensive services for the installation, maintenance, modification, and repair of Storage Tanks, Pressure Vessels, and associated Piping systems (both underground and above-ground) within Iraq's petroleum and refinery sector. Our experienced teams handle the construction and upkeep of this critical infrastructure, ensuring all work is executed according to rigorous industry standards and safety regulations. We focus on delivering solutions that support the operational integrity, reliability, and longevity of essential plant equipment.

Storage Tanks, Pressure Vessels & Piping Services





Refinery

Storage Tanks, Pressure Vessels & Piping Services





Refinery

Storage Tanks, Pressure Vessels & Piping Services

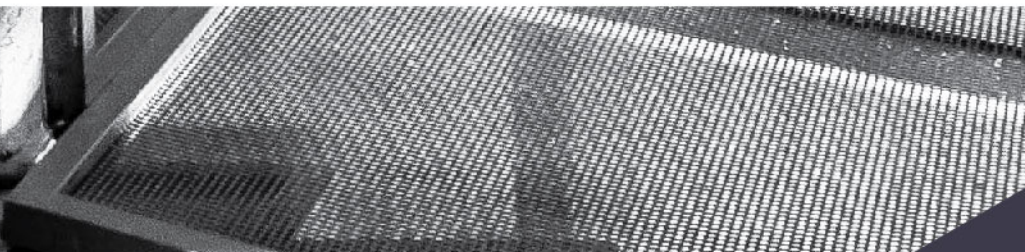



Refinery

Storage Tanks, Pressure Vessels & Piping Services





General Trading

Masdar Elemar International's General Trading division acts as a reliable and efficient bridge between suppliers and clients, facilitating the seamless flow of essential materials, equipment, and consumables. We leverage our extensive network and market knowledge to source and deliver high-quality products, ensuring timely and cost-effective solutions for our clients.

Fire Extinguisher





General Trading

Masdar Elemar International is a dedicated supplier providing a comprehensive range of electrical equipment to meet the specific needs of both Iraq's vital petroleum industry and various Iraqi Ministries. We source and deliver essential electrical components and systems, from specialized, heavy-duty equipment suitable for demanding oil, gas, and refinery environments (including hazardous area requirements) to the diverse electrical hardware needed for governmental infrastructure projects and facilities. Our focus is on supplying reliable, high-quality, and standards-compliant electrical solutions to support the critical operations and development projects across these key Iraqi sectors.

Electrical Equipment

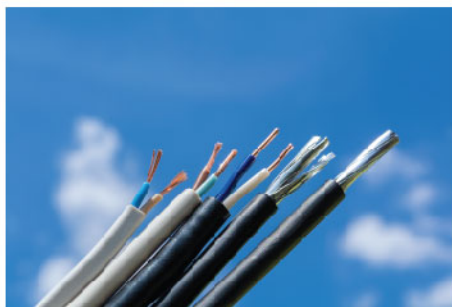



General Trading

Procurement of a wide range of industrial products, including:
Oil and gas equipment and supplies (e.g., pipes, valves, fittings, drilling equipment).

Construction materials (e.g., steel, cement, aggregates).

Electrical and instrumentation components.

Safety equipment and personal protective equipment (PPE).

Chemicals and consumables.

Machinery and spare parts.

HCL, Pantonite Chemical





General Trading

Procurement of a wide range of industrial products, including:
Oil and gas equipment and supplies (e.g., pipes, valves, fittings, drilling equipment).

Construction materials (e.g., steel, cement, aggregates).

Electrical and instrumentation components.

Safety equipment and personal protective equipment (PPE).

Chemicals and consumables.

Machinery and spare parts.

Oil Well Cement





General Trading

Procurement of a wide range of industrial products, including:
Oil and gas equipment and supplies (e.g., pipes, valves, fittings, drilling equipment).

Construction materials (e.g., steel, cement, aggregates).

Electrical and instrumentation components.

Safety equipment and personal protective equipment (PPE).

Chemicals and consumables.

Machinery and spare parts.

Pumps

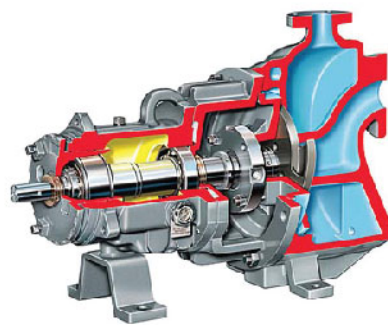



General Trading

Procurement of a wide range of industrial products, including:
Oil and gas equipment and supplies (e.g., pipes, valves, fittings, drilling equipment).

Construction materials (e.g., steel, cement, aggregates).

Electrical and instrumentation components.

Safety equipment and personal protective equipment (PPE).

Chemicals and consumables.

Machinery and spare parts.

Iron Pipes

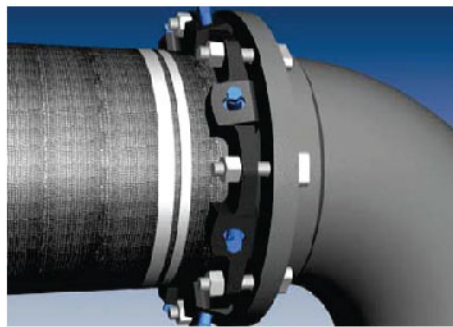



General Trading

Procurement of a wide range of industrial products, including:
Oil and gas equipment and supplies (e.g., pipes, valves, fittings, drilling equipment).

Construction materials (e.g., steel, cement, aggregates).

Electrical and instrumentation components.

Safety equipment and personal protective equipment (PPE).

Chemicals and consumables.

Machinery and spare parts.

PVC & PPR Pipes

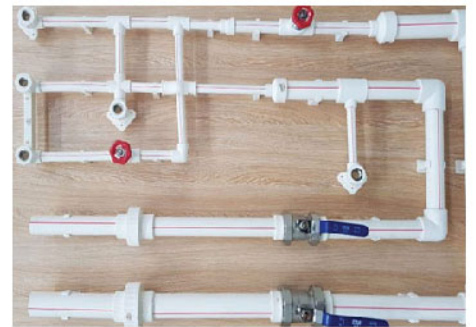



General Trading

Procurement of a wide range of industrial products, including:
Oil and gas equipment and supplies (e.g., pipes, valves, fittings, drilling equipment).

Construction materials (e.g., steel, cement, aggregates).

Electrical and instrumentation components.

Safety equipment and personal protective equipment (PPE).

Chemicals and consumables.

Machinery and spare parts.

Geophone





General Trading

Masdar Elomar International provides comprehensive IT and Security solutions, combining the supply of modern equipment with expert technical services. We offer a wide range of essential IT hardware (including computing devices, servers, and networking infrastructure) alongside advanced security systems such as CCTV surveillance, access control, and intrusion detection. Beyond equipment supply, our professional services encompass system design, installation, configuration, integration, ongoing maintenance, and technical support, ensuring our clients benefit from robust, reliable, and secure technology environments tailored to their operational needs in Iraq.

IT & Security





General Trading

Masdar Elemar International provides reliable sourcing and supply of automotive spare parts to meet the diverse maintenance requirements of industrial, commercial, and governmental clients in Iraq. We offer a comprehensive range of genuine and high-quality OEM-equivalent replacement parts for various types of vehicles and equipment, including light commercial vehicles, heavy trucks, construction machinery, and specialized industrial fleets. Our focus is on efficiently delivering the necessary parts to support fleet readiness, minimize equipment downtime, and ensure the operational continuity of our clients' essential vehicles and machinery.

Auto Spare Parts





Masdar Elemar International

Suliamayah
Germany Village
Building K, F2, Office 4

Erbil
Italy City 1, Office 655

Missan
Omarah, Ouashah,
Nearby Tax Office

Dubai - U.A.E.
7WB 1074, Dubai Airport Freezone
P.O. Box: 371225, Dubai - U.A.E.
tel: +971 58 227 0409

info@masdareleamar.com
www.masdareleamar.com

Baghdad
Head Office: Jaderyah,
Nearby Baghdad
University

Baghdad
Karada - Karada Dakhel

Basra
Al Jazzier Street, Nearby
Al Jazzier Park

Middle of Iraq
Wassit - Al - Kut
Al Horra St. Iraq

Belgium
Rue Général Gratry 78,
1030 Schaerbeek, Belgium
+32472131438

